

ASSEMBLY INSTRUCTION

1

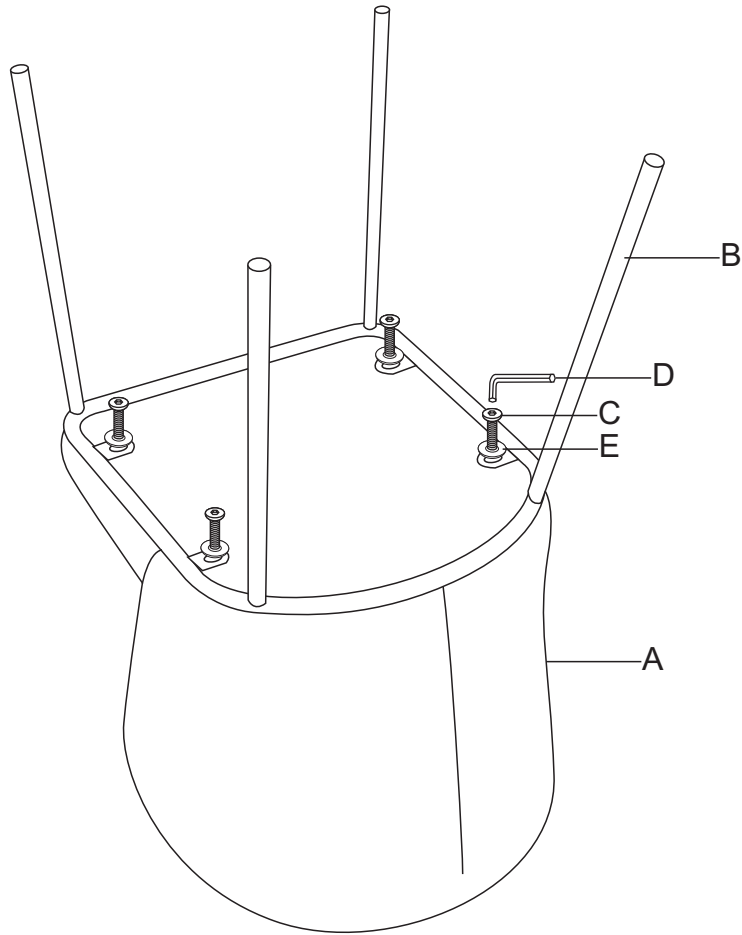

2

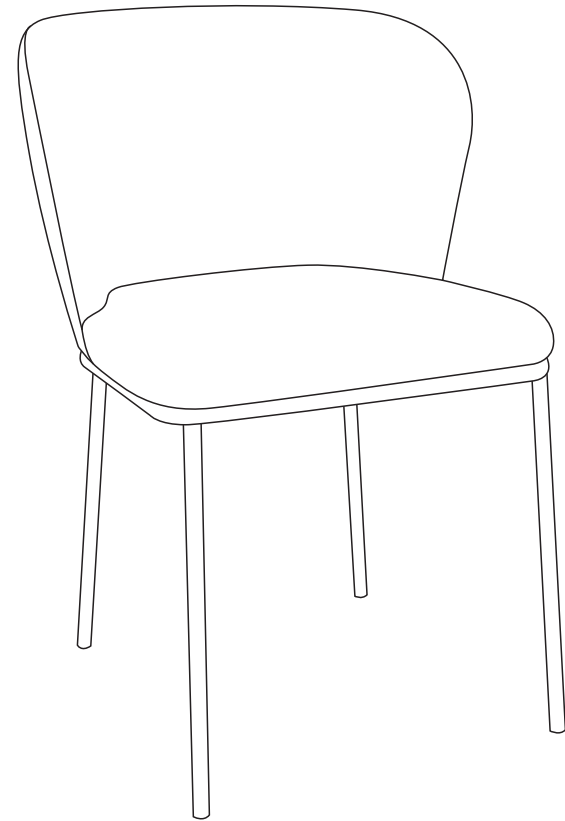

Ax1



Bx4



Cx4



Dx1



Ex4

